

LUNA STAT THERMOSTAT MANUAL

ambiente®

What is the Luna Stat	3	LCD display	24
Installation procedure	6	Change/check temperature	26
Setting program mode	8	Setback temperature	27
<b>Programmable mode</b>	<b>9</b>	<b>Features available on all program modes</b>	<b>28</b>
LCD display	10	Frost protection	28
Setting the clock	13	Setting the hold mode	29
Change/check temperature	14	Keypad lock	30
Schedule and comfort settings	15	Floor limit protection	31
Setting the holiday mode	17	Factory reset	32
Optimum start	18	Optional features explained	33
<b>Non-Programmable mode</b>	<b>19</b>	Changing optional features	36
LCD display	20	Optional features table	37
Change/check temperature	22	Error codes	39
<b>Setback thermostat mode</b>	<b>23</b>	Wiring diagrams	40

## WHAT IS THE LUNA STAT

---

The Luna Stat is a multi-function thermostat for underfloor heating, radiators or any other form of heating where multifunction temperature control is required.

The Luna Stat consists of two main modes

1. Standalone programmable/non-programmable thermostat
2. Set back thermostat with central programmer

## 1. PROGRAMMABLE/NON-PROGRAMMABLE THERMOSTAT

---

The Luna Stat operates by itself as independent control to the rest of the heating system as a thermostat in either programmable or non/programmable operation.

A. Non Programmable – operates as a simple thermostat where the temperature is held at the set point continuously.

B. Programmable – operates as a fully programmable thermostat with 4 times at which to set a target temperature. This enables you to regulate the temperature in your home by setting specific temperatures for times of day.

This way the thermostat doesn't operate the heating as On/Off but as an Up/Down control to the specific temperatures you set on your Luna Stat.

This enables you to have intricate control in each room creating a micro climate in different areas of your home and regulating the temperature for night, for when your home is unoccupied, or even when individual rooms are unoccupied or not used.

## 2. SET BACK THERMOSTAT WITH CENTRAL PROGRAMMER

---

The Luna Stat operates as temperature control on a room by room basis in conjunction with a single programmer (supplied separately) providing central timed control for larger areas or whole houses.

The Luna Stat is set to non-programmable and maintains the temperature at the set point whilst the programmer is on. When the programmer is off the Luna Stat automatically drops the set temperature by up to 5°C for example during the night or whilst the property is unoccupied.

This enables the operation of an efficient system with simple to use thermostat and central programmer rather than multiple thermostats that need programming one at a time.

## INSTALLATION PROCEDURE

---

Care should be taken on where the Luna Stat is installed, as being the ultimate control of your heating it is important that it is not installed near any secondary hot or cold sources. The Luna Stat should be installed at chest/eye level (approximately 1.5 metres) and where it will receive an even reading of the temperature of the room. It should be installed out of direct sunlight, away from draft or heat sources such as airing cupboards. The Luna Stat is designed to be mounted flush and will require an electrical back box with a depth of at least 35mm.

**Step 1**

Separate the two halves of the thermostat by using a small flat screwdriver to disengage the clips in the top edge of the Luna Stat.

**Step 2**

Ensure that the front (Screen) part of the thermostat is kept somewhere safe and clean. Terminate the cable for the thermostat in accordance with wiring diagrams on pages 40-43.

**Step 3**

Fix the thermostat back plate back to the back box with the screws provided, ensuring this is secure.

**Step 4**

Clip the front on to the back plate engaging the bottom clips first.

## SETTING YOUR PROGRAM MODE SELECTION

---

This Luna Stat has been set by default to a Programmable thermostat in 5+2 day programming (Weekdays + Weekend).

To change between programmable, non-programmable and set back thermostat follow these steps.

1. Press MENU till the 'SET SETUP' main menu item flashes.
2. Press OK 5 times, or until the small digits show '05'.
3. Press ▲▼ to change the large number for the following modes
  - 00 – Non Programmable/Set back thermostat
  - 01 = Weekday/Weekend programmable
  - 02 = 7 day programmable
4. Press OK 10 times, or until the small digit shows '15'.
5. Press ▲▼ to change the large number for the following modes
  - 00 – Setback thermostat disabled
  - 01 = Setback thermostat enabled (non-programmable only)
6. Press MENU to save the setting and the ⏪ button to return to the home screen.



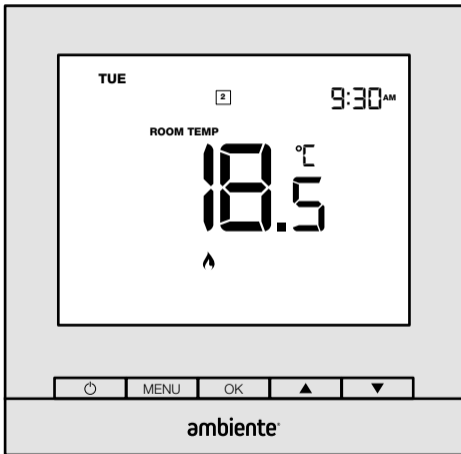

## LCD DISPLAY

PROGRAMMABLE MODE (5+2 AND 7 DAY)

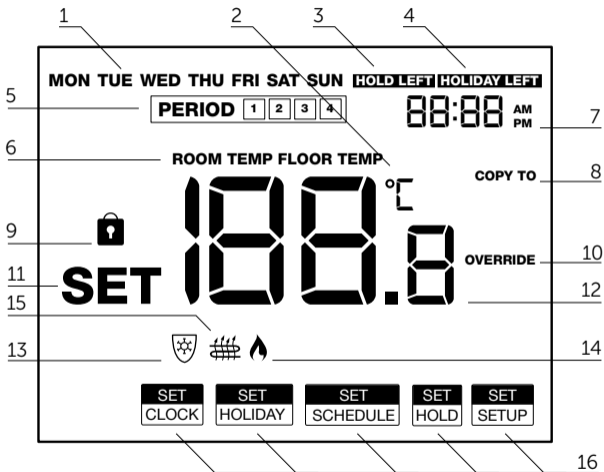

1. Day of the week – Displays the current day.
2. Temperature unit – Degrees Celsius (°C) or Fahrenheit (°F).
3. Hold Left indicator. – Displays when the HOLD FOR function is active along with the hours of hold remaining.
4. Holiday Left indicator – Displays when the holiday function is active along with the number of days remaining.
5. Time Period – Displays the current program period as set in the program of the thermostat.
6. Room/Floor Temperature – Indicates the current sensor set up and point of temperature measurement.
7. Time – Displays the current time in 24 or 12 hour format.
8. Copy function – Enables the copying of times between days.
9. Key pad Lock – Displays when the key pad is locked.
10. Override – Displays when a temporary override is set.

## LCD DISPLAY

---

11. SET – Displays when any program or parameter is being changed.
12. Temperature – Displays the current sensor temperature.
13. Frost Shield – Displays when the thermostat is in frost protection mode.
14. Flame Symbol – Displays when the thermostat is calling for heat.
15. Floor Protection – Displays when the floor limit temperature is reached.
16. Main Menu – Displays when setting schedule and feature parameters.

## SETTING THE CLOCK

---

To set/change the clock and day follow these steps. This is not applicable if the thermostat is in non-program mode.

1. Press MENU so the 'SET CLOCK' main menu item flashes.
2. Press OK to confirm. The current hour will flash
3. Press ▲▼ to change the hour and press OK.
4. Press ▲▼ to change the minute and press OK.
5. Press ▲▼ to change the day and press OK.
6. Press MENU to save the change and the ⏪ button to return to the home screen.

## CHANGE/CHECK THE TEMPERATURE SETTING

---

To set/change the temperature (temporary override) follow these steps. Note, this only changes the temperature until the next program time.

1. Press ▲▼ once to view the current temperature setting.
2. Press ▲▼ repeatedly to change the thermostat in increments of 0.5°C.
3. Press OK to save the new temperature and return to the home screen. The thermostat will display 'OVERRIDE' to confirm a different temperature has been set.

The 🔥 symbol will show when the thermostat is calling for heat.

If a floor sensor has been installed this temperature can be checked by press and holding the 'OK' button. The thermostat will return to the home screen after 10 seconds.

You can also change the temperature this way in the Frost, Holiday and Hold modes.

## SCHEDULE AND COMFORT SETTINGS

The Luna Stat comes pre-programmed with comfort levels set. These factory default settings are:

<b>Week Day and Weekend – 5/2 day programming</b>				
Mon-Fri	5.30 - 20°C	8.00 - 16°C	16.00 - 20°C	22.00 - 16°C
Sat-Sun	6.30 - 20°C	9.00 - 16°C	16.00 - 20°C	23.00 - 16°C

<b>Monday to Sunday – 7 day programming</b>				
Mon-Sun	5.30 - 20°C	8.00 - 16°C	16.00 - 20°C	22.00 - 16°C

To set/change the program comfort levels follow these steps.

1. Press MENU to display the main menu items.
2. Press MENU till the 'SCHEDULE' main menu item flashes.
3. Press OK to confirm. 'MON ~ FRI' will flash.
4. Press ▲▼ to select different day(s) and press OK.
  - 'Period 1' is displayed and the corresponding hour flashes.

## SCHEDULE AND COMFORT SETTINGS

---

5. Press ▲▼ to change the hour for 'Period 1'.
6. Press OK to confirm and minute for 'Period 1' flashes.
7. Press ▲▼ to change the minute for 'Period 1'.
8. Press OK to confirm and temperature for 'Period 1' flashes.
9. Press ▲▼ to change the temperature for 'Period 1'.
10. Press OK to confirm.
  - 'Period 2' is displayed and the corresponding hour flashes.
11. Repeat steps 5 to 10 for Periods 2, 3 & 4.
12. After pressing OK for 'Period 4', 'COPY TO' will flash.
  - a. Press ▲▼ to cancel copy function and set other days manually.
  - b. Press OK to apply copy function.

*Note: When set to 5+2 day programming, pressing OK skips points c and d.*

  - c. Press ▲ to select a day, press ▼ to deselect a day.

*Note: Selected days are shown without flashing.*
  - d. Press OK to save the copy and Luna Stat returns to main menu.
13. Repeat steps 2-12 to set and/or copy further days.
14. Press MENU to save the change and the ⏪ button to return to the home screen.



## SETTING THE HOLIDAY MODE

---

To set/change the Holiday mode follow these steps. (This is not applicable in non-programmable mode.)

1. Press MENU till the 'SET HOLIDAY' main menu item flashes.
2. Press OK to confirm. The 'HOLIDAY LEFT' symbol will show and the number of days will flash.
3. Press ▲▼ to change the number of days the holiday should be set for (Note: Holiday starts from 00:00 of the next day and ends on 23:59 of the last day).
4. Press OK to confirm and the temperature for the holiday will flash.
5. Press ▲▼ to change the temperature for the holiday period.
6. Press MENU to save the holiday and the ⏪ button to return to the home screen.

*Note: Setting Holiday mode will remove any Hold mode set - see page 29.*

## OPTIMUM START

---

The Luna Stat will typically turn the heating on at the time set in the program. With the optimum start feature enabled the Luna Stat will display a flashing 🔥 symbol and turn the heating on beforehand in order to reach the required temperature for the time set. See page 33 for further details and page 36 for details on enabling this optional feature.

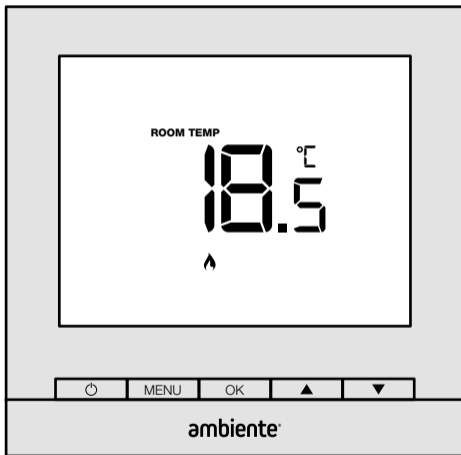

## LCD DISPLAY

NON-PROGRAMMABLE MODE

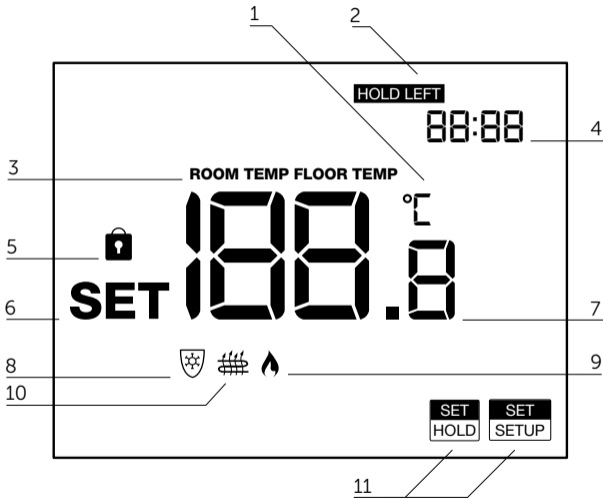

1. Temperature unit – Degrees Celsius (°C) or Fahrenheit (°F).
2. Hold Left indicator – Displays when the HOLD FOR function is active along with the hours of hold remaining.
3. Room/Floor Temperature – Indicates the current sensor set up and point of temperature measurement.
4. Time – Displays the current hold time left when in hold mode.
5. Key pad Lock – Displays when the key pad is locked.
6. SET – Displays when any program or parameter is being changed.
7. Temperature – Displays the current sensor temperature.
8. Frost Shield – Displays when the thermostat is in frost protection mode.
9. Flame Symbol – Displays when the thermostat is calling for heat.
10. Floor Protection – Displays when the floor limit temperature is reached.
11. Main Menu – Displays when setting schedule and parameters.

## CHANGE/CHECK THE TEMPERATURE SETTING

---

To set/change the temperature follow these steps.

1. Press ▲▼ once to view the current temperature setting.
2. Press ▲▼ repeatedly to change the thermostat in increments of 0.5°C.
3. Press OK to save the new temperature and return to the home screen.

The 🔥 symbol will show when the thermostat is calling for heat.

If a floor sensor has been installed this temperature can be checked by press and holding the 'OK' button. The thermostat will return to the home screen after 10 seconds.

You can also change the temperature this way in the Frost and Hold modes.

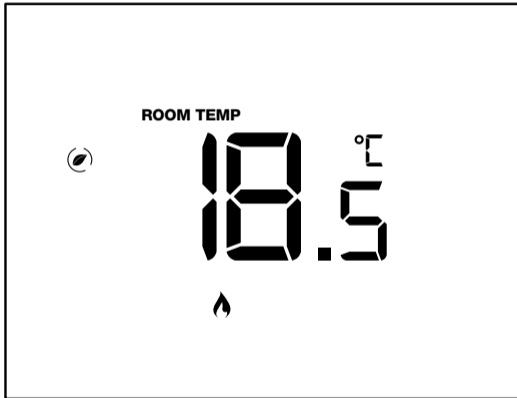

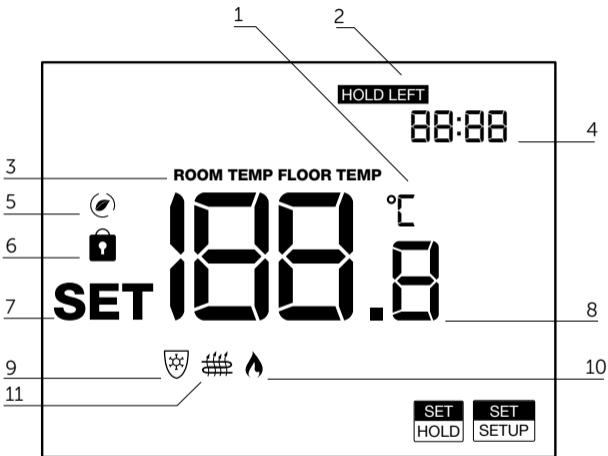



## LCD DISPLAY

---

1. Temperature unit – Degrees Celsius (°C) or Fahrenheit (°F).
2. Hold Left indicator. – Displays when the HOLD FOR function is active along with the hours of hold remaining.
3. Room/Floor Temperature – Indicates the current sensor set up and point of temperature measurement.
4. Time – Displays the current hold time left when in hold mode.
5. Setback – Is displayed when Luna Stat is in temperature set-back.
6. Key pad Lock – Displays when the key pad is locked.
7. SET – Displays when any program or parameter is being changed.
8. Temperature – Displays the current sensor temperature.
9. Frost Shield – Displays when the thermostat is in frost protection mode.
10. Flame Symbol – Displays when the thermostat is calling for heat.
11. Floor Protection – Displays when the floor limit temperature is reached.

## CHANGE/CHECK THE TEMPERATURE SETTING

---

To set/change the temperature follow these steps.

1. Press ▲▼ once to view the current temperature setting.
2. Press ▲▼ repeatedly to change the thermostat in increments of 0.5°C.
3. Press OK to save the new temperature and return to the home screen.

The 🔥 symbol will show when the thermostat is calling for heat.

If a floor sensor has been installed this temperature can be checked by press and holding the 'OK' button. The thermostat will return to the home screen after 10 seconds.

You can also change the temperature this way in the Frost and Hold modes.

## SETBACK TEMPERATURE

---

The Luna Stat operates a built in temperature set-back when a timer/ programmer is connected to the Luna stat. This set back is adjustable using the following steps.

1. Press MENU till the 'SET SETUP' main menu item flashes.
2. Press OK 16 times, or until the small digit shows '16'.
3. Press ▲▼ to change the large number for the following modes  
03 – 05 = 3°C - 6°C
4. Press MENU to save the setting and the  button to return to the home screen.

## FEATURES AVAILABLE ON ALL PROGRAM MODES

---

### FROST PROTECTION

To set the thermostat in frost protection mode press the  button. The  symbol will display indicating that the thermostat is in frost mode and set to a lower temperature – factory default of 12°C

## SETTING THE HOLD MODE

---

To set/change the Hold mode follow these steps.



1. Press MENU till the 'SET HOLD' main menu item flashes.
2. Press OK to confirm. The 'HOLD LEFT' symbol will show and the number of hours flash.
3. Press ▲▼ to change the number of hours the hold should be set for.
4. Press OK to confirm and the temperature for the hold period will flash.
5. Press ▲▼ to change the temperature for the hold period.
6. Press MENU to save hold period and the ⏪ button to return to the home screen.

*Note: Hold mode cannot be set if Holiday mode is already set - see page 17.*

## KEYPAD LOCK

---

The Luna Stat keypad can be locked to prevent any accidental adjustment or tampering of the thermostat.

Press and hold ▲ and ▼ until the  symbol shows. Keypad is now locked. Press and Hold ▲ and ▼ until the  symbol disappears to unlock the Luna Stat.

## FLOOR LIMIT PROTECTION

---

If a floor sensor has been installed with the Luna Stat this enables a floor limit temperature to be set and controlled through the optional features, explained on pages 33-35. This will stop the heating when the floor temperature reaches this point and will show the # symbol.

## FACTORY RESET

---

Should the Luna Stat need to be reset to factory default settings follow these steps.

Press and Hold the  Button to turn the Luna Stat off.

Press and hold  and .

The Luna Stat will display all icons on the screen for 2 seconds. The Factory reset is now complete.



## OPTIONAL FEATURES EXPLAINED

---

The following settings are optional parameters to change how the thermostat works and what it displays. In many cases these need not be adjusted.

**Feature 01 – Sensor Selection:** The Luna Stat has the option of using its own built in air sensor (default), a remote air sensor, floor sensor or a combination of these sensors for floor limit protection when both an air and floor sensor are used.

**Feature 02 – Time Format:** The Luna Stat has the option of displaying the time in 24 (default) and 12 hour format.

**Feature 03 – Temperature Format:** The Luna Stat has the option of displaying the temperature in Celsius°C (default) and Fahrenheit °F.

**Feature 04 – Frost Protection:** The Luna Stat has the option to maintain frost protection even when the thermostat is off, as long as power is still maintained to the thermostat. When the thermostat is off it will continue to show  symbol. This feature is enabled by default.

**Feature 05 – Program Mode:** The Luna Stat has the option to operate as a non-programmable thermostat or a programmable thermostat with 5/2 day or 7 day programming. Default is programmable 5/2 day.

## OPTIONAL FEATURES EXPLAINED

---

**Feature 06 – On/Off Status:** The Luna Stat can be set to come on or stay off when power is turned on to the thermostat. Default is auto on/off from last power off.

**Feature 07 – Temperature Calibration:** The Luna Stat has the option to adjust the sensor calibration by +/- 10°C in 0.5°C increments. Default is 0°C.

**Feature 08 – Switching Differential:** The Luna Stat has the option to changing the switching differential between 1 and 3°C. Default is 1°C.

**Feature 09 – Maximum Temperature:** The Luna Stat has the option to adjusting the maximum temperature set point. This can be used as a limit on how high the heating is set to. This range is from 2°C to 49.5°C. Default is 35°C.

**Feature 10 – Minimum Temperature:** The Luna Stat has the option to adjusting the minimum temperature set point. This can be used as a limit on how low the heating is set to. This range is from 0°C to 47.5°C. Default is 5°C.

**Feature 11 – Output Delay:** The Luna Stat has the option to delay.

## OPTIONAL FEATURES EXPLAINED

---

the switch output to prevent rapid switching on and off. This can be set from 00 – 15 minutes. Default is 00.

**Feature 12 – Optimum Start:** The Luna Stat has the option to set an optimum start of up to 3 hours, see page 18 for more detail. Default is 0 hours.

**Feature 13 – Rate of Change:** For information only.

**Feature 14 – Floor Temperature Limit:** The Luna Stat has the option to adjust the floor limit temperature used when a floor sensor is installed and connected. This range is from 20°C to 60°C. Default is 28°C.

**Feature 15 – Setback Enable:** The Luna Stat has the option to be programmed as a setback thermostat controlled from a separate programmer. The programmer switched live should be connected to the  terminal. Program mode (Feature 5) needs to be set to 00 (non-programmable) to enable this feature.

**Feature 16 – Setback Temperature:** The Luna Stat has the option to adjust the setback temperature from 3°C to 5°C. Default is 4°C.

## CHANGING THE OPTIONAL FEATURES

---

To change the optional features on the Luna Stat follow these steps, selecting the required feature number and setting value.

1. Press MENU till the 'SET SETUP' main menu item flashes.
2. Press OK to confirm. The small digits display the feature number, the large digits display the setting value for the feature.
3. Press OK to cycle through the feature numbers.
4. Press ▲▼ to change setting number for each feature.
5. Press MENU to save the setting and the  button to return to the home screen.

## OPTIONAL FEATURE TABLE

Feature No.	Description	Setting No.
01	Sensor Selection	00=Internal air sensor (Default) 01=Remote air sensor 02=Remote floor sensor 03=Internal air and remote floor sensor 04=Remote air and remote floor sensor
02	Time Format	12=12 hour, 24=24 hour (default)
03	Temperature Format	00=°C (Default), 01=°F
04	Frost Protection when off	00=Enabled (Default) 01=Disabled
05	Program Mode	00=Non Programmable 01=5/2 day programmable (Default) 02=7 day programmable
06	On/Off Status	00=Off when powered up 01=On when powered up 02=Auto memory when power lost (Default)
07	Temperature Calibration	-10°C ~ +10°C (-18°F ~ +18°F) (Default =0)
08	Switching Differential	1°C ~ 3°C (2°F ~ 5°F) (Default =1°C)
09	Maximum Temperature	2°C ~ 49.5°C (36°F ~ 121°F) (Default =35°C)
10	Minimum Temperature	0°C ~ 47.5°C (32°F ~ 117°F) (Default =5°C)
11	Output Delay	00 ~ 15 minutes (Default = 00)

## OPTIONAL FEATURE TABLE

---

12	Optimum Start	00 ~ 03 hours (Default = 00)
13	Rate of Change	Information only, non-adjustable
14	Floor Temperature Limit	20°C ~ 60°C (68°F ~ 140°F) (Default =28°C)
15	Setback Enable	00=OFF (Default) 01=ON
16	Setback Temperature	3°C ~ 5°C (5°F ~ 9°F) (Default =4°C)

Use the following table to determine and resolve error codes.

Code	Fault/Error	Solution
E0	Internal sensor fault	Replace thermostat
E1	Remote floor sensor fault	Check programming for sensors – optional feature 01 Check floor sensor connections Check for damage on floor sensor or incorrect floor sensor resistance
E2	Remote air sensor fault	Check programming for sensors – optional feature 01 Check air sensor connections Check for damage on air sensor or incorrect air sensor resistance
HI	Temperature higher than 55°C	Move thermostat to a cooler area Check for influence from external heat source Check Luna Stat calibration
LO	Temperature lower than 0°C	Move thermostat to warmer area Check for influence from draught or external cooling Check Luna Stat calibration Start heating to increase room temperature.

## WIRING DIAGRAMS

Luna Stat basic wiring diagram with switch live for heat item.

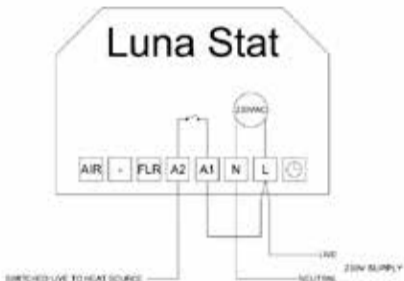

This product must only be installed in accordance with local installation regulations and by a qualified electrician



Luna Stat wiring diagram with volt free switching for heat item.

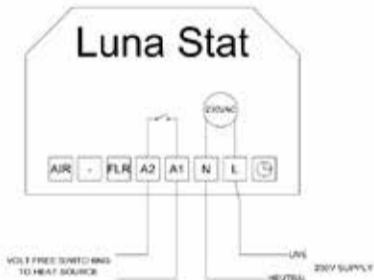

This product must only be installed in accordance with local installation regulations and by a qualified electrician

## WIRING DIAGRAMS

Luna Stat wiring diagram connecting to UH8 Wiring Centre.

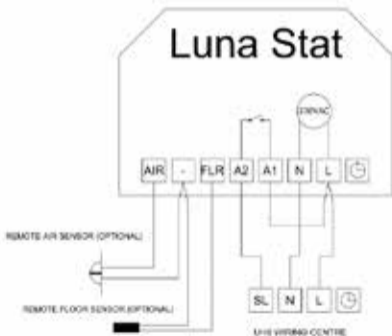

This product must only be installed in accordance with local installation regulations and by a qualified electrician

Luna Stat basic wiring diagram in setback mode connecting to UH8 Wiring Centre.

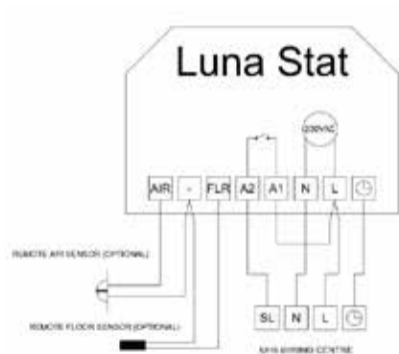

This product must only be installed in accordance with local installation regulations and by a qualified electrician

Need more information or advice?  
Contact our team of highly trained experts today.



**01707 649 118**



**info@ambienteufh.co.uk**



**www.ambienteufh.co.uk**

**LUNA STAT THERMOSTAT MANUAL**

**ambiente<sup>®</sup>**